

Service Manual

THE FISHER®

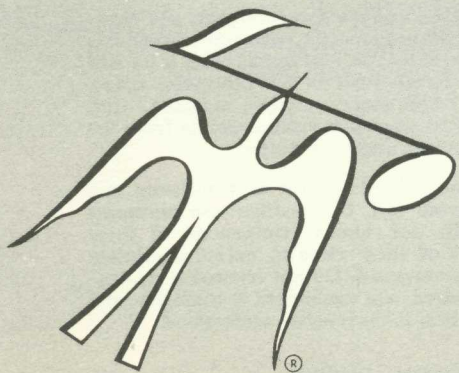
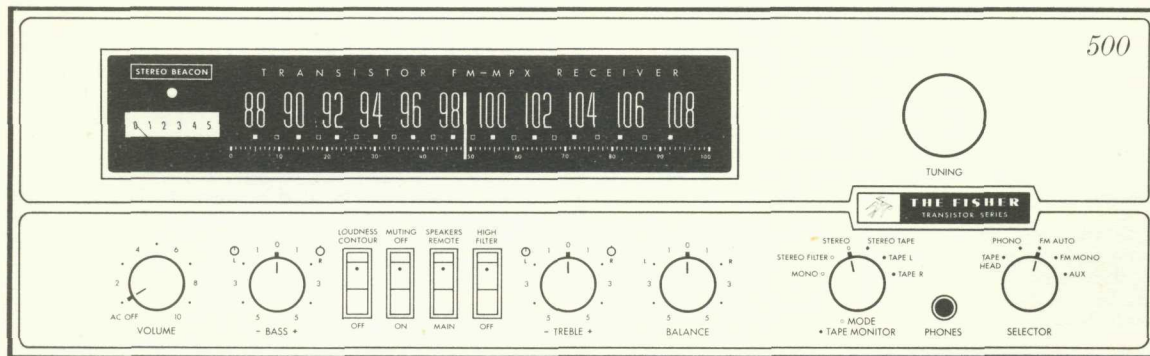

500-T

CHASSIS SERIAL NUMBERS
BEGINNING 10001

PRICE \$1.00

CAUTION: This is a FISHER precision high-fidelity instrument. It should be serviced only by qualified personnel — trained in the repair of transistor equipment and printed circuitry.

TEST EQUIPMENT REQUIRED

The following are needed to completely test and align modern high-fidelity instruments such as amplifiers, tuners and receivers.

Vacuum-Tube Voltohmmeter (100-mV DC scale)	10.7-MHz Sweep Generator
Audio Vacuum-Tube Voltmeter (10-mV AC scale)	455-kHz Sweep Generator
Oscilloscope (Flat to 100 kHz Minimum)	Line Voltage Autotransformer or Voltage Regulator
Audio (Sine-Wave) Generator	2 — Load Resistors, 4 or 8 Ohm, 50 Watt
Intermodulation Distortion Analyzer	2 — Full Range Speakers for Listening Tests
Harmonic Distortion Analyzer	Stereo Source — Turntable or Tape Recorder for Listening Tests
AM/FM Signal Generator	Soldering Iron with Small Tip Fully Insulated from Power Line
Multiplex Generator (preferably with RF output — FISHER Model 300 or equal)	Suction Desoldering Tool

PRECAUTIONS

Many of these items are included just as a reminder — they are normal procedures for experienced technicians. Short-cuts can be taken but often they cause additional damage — to transistors, circuit components or the printed-circuit board.

Soldering—A well-tinned, hot, clean soldering iron tip will make it easier to solder without damage to the printed-circuit board or the many circuit components mounted on it. It is not the wattage of the iron that counts — it is the heat available at the tip. Some 50-watt irons reach temperatures of 1,000° F — others will hardly melt solder. Small-diameter tips should be used for single solder connections — larger pyramid and chisel tips are needed for larger areas.

- When removing defective resistors, capacitors, etc., the leads should be cut as close to the body of the circuit component as possible. (If the part is not being returned for in-warranty factory replacement it may be cut in half — with diagonal-cutting pliers — to make removal easier.)

- Special de-soldering tips are made for unsoldering multiple-terminal units like IF transformers and electrolytic capacitors. By unsoldering all terminals at the same time the part can be removed with little chance of breaking the printed-circuit board.

- Always disconnect the chassis from the power line when soldering. Turning the power switch OFF is not enough. Power-line leakage paths, through the heating element, can destroy transistors.

Transistors—Never attempt to do any work on the transistor amplifiers without first disconnecting the AC linecord and waiting until the power supply filter-capacitors have discharged.

- Guard against shorts — it takes only an instant for a base-to-collector short to destroy that transistor and possibly others direct-coupled to it. [In the time it takes for a dropped machine screw, washer or even the screwdriver, to glance off a pair of socket terminals (or between a terminal and the chassis) a transistor can be ruined.]

- DO NOT bias the base of any transistor to, or near, the same voltage applied to its collector.

- DO NOT use an ohmmeter for testing transistors. The voltage applied through the test probes may be higher than the base-emitter breakdown voltage of the transistor.

Output Stage and Driver — Replacements for output and

driver transistors, if necessary, must be made from the same beta group as the original type. The beta group is indicated by a colored dot on the mounting flange of the transistor. Be sure to include this information, when ordering replacement transistors.

- If one output transistor burns out (open or shorts), always remove ALL output transistors in that channel and check the bias adjustment, the control and other parts in the network with an ohmmeter before inserting a new transistor. All output transistors in one channel will be destroyed if the base-biasing circuit is open on the emitter end.

- When mounting a replacement power transistor be sure the bottom of the flange, the mica insulator and the surface of the heat sink are free of foreign matter. Dust and grit can prevent perfect contact reducing heat transfer to the heat sink. Metallic particles can puncture the insulator and cause shorts — ruining the transistor.

- Silicone grease must be used between the transistor and the mica insulator and between the mica and the heat sink for best heat conduction. (Use Dow-Corning DC-3 or C20194 or equivalent compounds made for power transistor heat conduction.)

- Use care when making connections to speakers and output terminals. Any frayed wire ends can cause shorts that may burn out the output transistors — they are direct-coupled to the speakers. To reduce the possibility of shorts at the speakers, lugs should be used on the exposed ends or at least the ends of the stranded wires should be tinned to prevent frayed wire ends. The current in the speakers and output circuitry is quite high. Poor contacts or small size wire can cause power losses in the speaker system. Use 14 or 16 AWG for long runs of speaker wiring.

Voltage Measurements—Voltage measurements are made with the line voltage adjusted to 117 volts and all readings are $\pm 10\%$. All voltages are DC, measured with a VTVM to ground, with no signal input unless otherwise noted. indicates 1-kHz audio voltages, measured with an audio AC VTVM to ground at various points from the phono input to the power amplifier output.

Alignment Procedures — Replacement of transistors and components in the front end, IF amplifier and multiplex decoder will normally not require realignment of these circuits. Realignment of these circuits, unless absolutely necessary, is not recommended. Do not attempt a realignment unless the required test equipment is available and the alignment procedure is thoroughly understood.

BECAUSE ITS PRODUCTS ARE SUBJECT TO CONTINUOUS IMPROVEMENT, FISHER RADIO CORPORATION RESERVES THE RIGHT TO MODIFY ANY DESIGN OR SPECIFICATION WITHOUT NOTICE AND WITHOUT INCURRING ANY OBLIGATION.

DIAL STRINGING

- Turn the tension screw to its maximum clockwise in position.
- Rotate the tuning capacitor drive drum to its maximum clockwise position. Tie the end of the dial cord to the ear inside the top of the drive drum (detail view).
- Run the dial cord through the slot in the drive drum. Position the dial cord in the underside of the inner groove of the drive drum.
- Place the dial cord on pulleys A and B.
- Wrap two full turns of the dial cord around the tuning shaft.
- Position dial cord on other pulleys and over the top of the tuning-capacitor drive-drum.
- Pull the dial cord taut and wrap 2½ turns around the outer groove of the drive drum. Run the dial cord through the slot in the drive drum and under the beveled washer (detail view). Tighten the machine screw to hold the dial cord, making certain that the tension screw is in contact with the screw stop.
- Turn the tension screw counterclockwise to hold the dial cord under tension so that the flywheel rotates freely but the dial cord does not slip on the tuning shaft.
- Place the dial cord over and under the tabs on the rear of the dial pointer. Place the dial pointer on the top of the chassis front panel.

REPLACING METER LAMP

- Disconnect AC power cord.
- Remove the screws which hold the top cover to the chassis and lift off the top cover.
- Gently push in on the lamp and turn it counterclockwise to remove. Remove the metal lamp shade and place it on the new lamp in the same position. Place the new lamp in the socket, push in gently and turn it clockwise to lock it in place.
- Replace the top cover on the chassis and secure with the screws removed previously.

REPLACING STEREO BEACON LAMP

- Disconnect AC power cord.
- Remove the screws which hold the top cover to the chassis and lift off the top cover.
- Pry nylon lamp holder from the lamp mount. Unsolder the leads from the lamp holder. Solder leads to rear terminals on the new lamp holder. Place new lamp holder in the mount.
- Replace the top cover on the chassis and secure with the screws removed previously.

CLEANING FRONT PANEL

WARNING: Use only plain lukewarm water and a freshly laundered, soft lint-free cloth to clean the front control panel.

REPLACING DIAL LAMPS

- Disconnect AC power cord.
- Gently pull all knobs off the front panel control shafts. Remove hex nuts from the control shafts and lift off the front panel.
- Snap out the defective lamp from the spring clip. Place the new lamp in the socket making certain that the unpainted side of the lamp faces the edge of the dial glass.
- Replace the front panel and secure with the hex nuts removed previously. Replace the knobs on the control shafts.

CLEANING DIAL GLASS

- Disconnect AC power cord.
- Gently pull all knobs off the front panel control shafts. Remove the hex nuts from the control shafts and lift off the front panel.
- If there are foam-cushion strips located at the ends of the dial glass, remove them.
- Loosen the screws that hold the retaining clips to the dial glass. Swing the clips aside and lift off the dial glass.
- Remove dust with a dry cloth. If you wish to clean more thoroughly, use a soap-and-water solution only; any stronger agent may damage the markings on the glass.
- Replace the dial glass and position it down and towards the left of the chassis front. Swing the retaining clips back into place and tighten the retaining-clip screws. Replace the foam-cushion strips, if removed previously.
- Replace the front panel and secure with the hex nuts removed previously. Replace the knobs on the control shafts.

POWER AMPLIFIER CENTER VOLTAGE ADJUSTMENT

- Connect two 10K, ±1% resistors in series across capacitor C19 (2500µF). Connect the common lead of a DC VTVM to the junction of the two resistors.
- Connect DC VTVM to the junction of resistors R37 and R39. Adjust Center Voltage Adjust Pot. R857 on left channel driver board for meter reading of 0 ±0.5 VDC.
- Connect DC VTVM to the junction of resistors R38 and R40. Adjust Center Voltage Adjust Pot. R857 on right channel driver board for meter reading of 0 ±0.5 VDC.
- Disconnect 10K resistors.

POWER AMPLIFIER IDLING CURRENT ADJUSTMENT

NOTE: This adjustment is to be performed only after completing Center Voltage Adjustment.

- Connect DC VTVM across resistor R37. Adjust Output Bias Adjust Pot. R858 on left channel driver board for meter reading of 40 ±10mV DC.
- Connect DC VTVM across resistor R38. Adjust Output Bias Adjust Pot. R858 on right channel driver board for meter reading of 40 ±10mV DC.

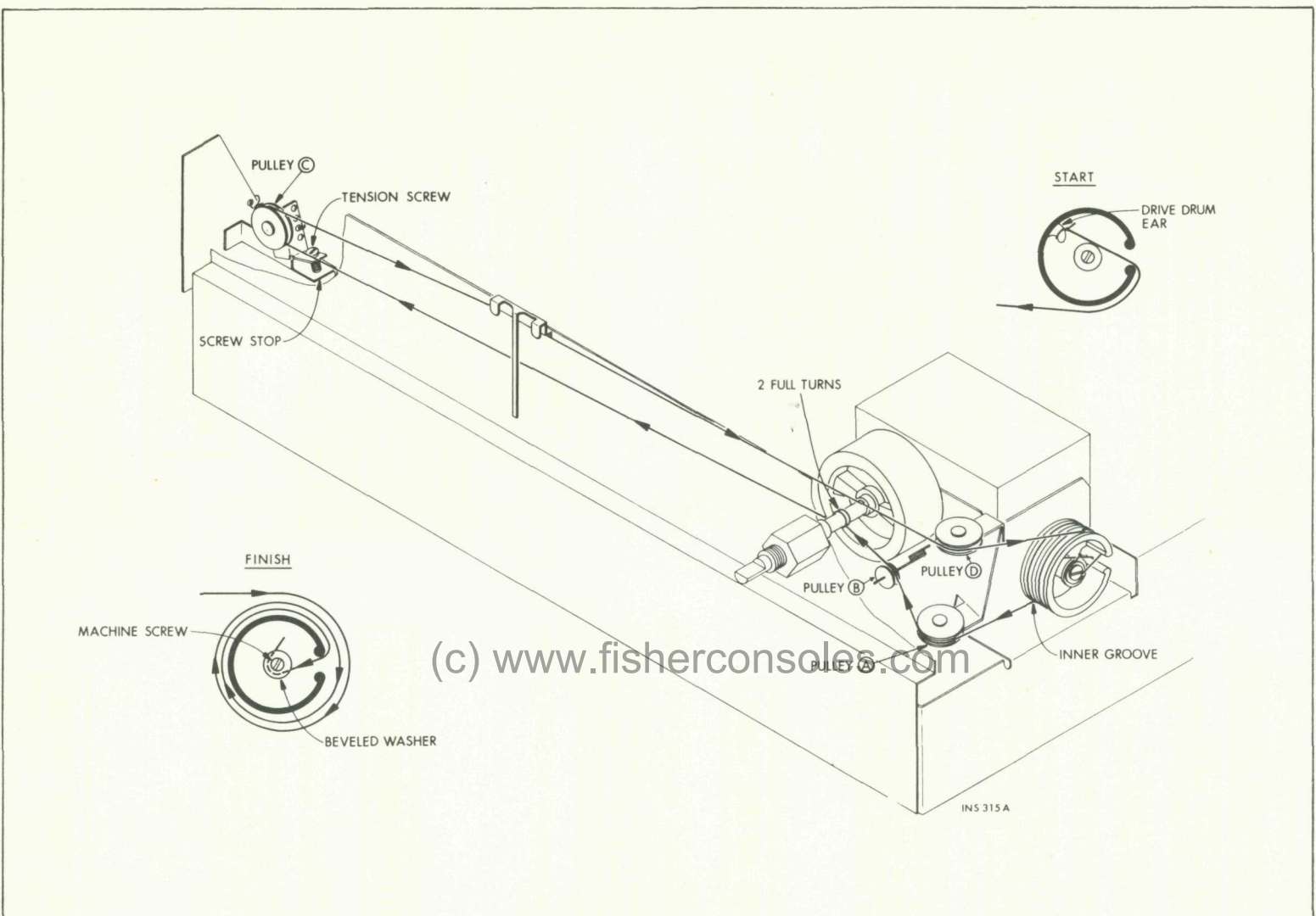

(c) www.fisherconsoles.com

SERVICE PROCEDURES

FRONT END ALIGNMENT

NOTE: IF alignment must be performed before starting this procedure.

- Set TUNING dial pointer to zero (0) calibration mark on the logging scale. If the dial pointer does not coincide with the 0 at the extreme end of the knob rotation, reposition the pointer assembly on the dial cord and cement the pointer in place to prevent slippage.
- Connect DC VTVM to TP301 on the IF board.
- Connect an RF generator to the NORM antenna terminals. Use a 120-ohm composition resistor in series with each lead from the generator—see Figure 1.
- Set RF generator frequency and TUNING dial pointer to 90 MHz (Mc). DO NOT USE MODULATION (AM or FM) and keep the generator output as low as possible during the alignment procedure.
- Align oscillator coil (L755) core first—then align the RF coils (L754, L753, L752) for maximum reading on DC VTVM.
- Set RF generator frequency and TUNING dial pointer to 106 MHz (Mc).
- Adjust oscillator trimmer (C769) first—then adjust the RF trimmers (C767, C761, C755) for maximum reading on DC VTVM.
- Repeat alignment several times until accurate dial calibration and maximum gain are observed. Keep the generator output as low as possible during all adjustments.
- Adjust RF generator for input of 200 mV, with no modulation, at NORM antenna terminals. Use speakers or headphones to monitor the output.
- Turn up VOLUME control until noise is heard in the output. Adjust RF generator for input of 1 mV; gradually increase generator output to 200 mV. There should be no audible increase in the noise level. If necessary, readjust slightly AGC Adjust Pot. R756 for no increase in noise as the generator is varied from 1 mV to 200 mV.

IF ALIGNMENT

- Connect 10.7-MHz (Mc) sweep generator to TP751 on front end. Disconnect jumper between terminals 3F and 3G on IF board. Connect scope vertical input through 220K resistor to TP301.
- NOTE:** Connect ground lead of generator to ground near TP751 and ground of scope closest to scope input.

- Adjust generator output voltage and frequency to observe IF response curve. Use as low a generator output as possible. Measure voltage at TP301 with DC VTVM during alignment and readjust generator output to keep meter reading from -1.4 to -2.0 VDC maximum.
- Detune top core of Z303 outwards.
- Align bottom core of Z303, top and bottom cores of Z302, Z301 and Z751 for maximum gain and symmetry—see Figure 1. Repeat alignment.
- Reconnect jumper between terminals 3F and 3G. Disconnect wire from TP302 (terminal 3N) and connect scope vertical input through 220K resistor to TP302.
- Align top core of Z303 for maximum gain and symmetry—see Figure 2.
- Disconnect scope and reconnect wire to TP302. Connect DC VTVM to TP302.
- Set generator output to 10.7 MHz (Mc) with no sweep. Vary generator voltage from minimum to maximum; reading on DC VTVM should increase with increase in signal.
- Connect DC VTVM across resistor R4. Vary generator voltage from minimum to maximum; reading on DC VTVM should decrease with increase in signal.
- Set generator voltage to 200mV. Adjust Meter Adjust Pot. R14 for tuning meter reading of 4.
- Connect scope vertical input through 220K resistor to terminal 3K.
- Set generator for sweep and adjust generator output voltage to observe ratio detector response. Use as low a generator output as possible.
- Adjust top and bottom cores of Z304 for maximum gain; re-adjust top core for best linearity—see Figure 3.

FM TUNING METER CALIBRATION

- Connect an FM generator to the NORM antenna terminals. Use a 120-ohm composition resistor in series with each lead from the generator.
- Set FM generator frequency and TUNING dial pointer to 90 MHz (Mc). Set generator output to 20 mV, ± 22.5 kHz (kc) deviation with 400 Hz (cps).
- Adjust top core of Z303 for maximum reading on tuning meter.
- Increase generator output to 200 mV. Adjust Meter Adjust Pot. R14 for meter reading of 4.5.

FM MUTING ADJUSTMENT

Set MUTING switch to OFF.

- Connect an FM generator to the NORM antenna terminals. Use a 120-ohm composition resistor in series with each lead from the generator.
- Connect AC VTVM to LEFT or RIGHT CHANNEL RCDR jack.
- Set FM generator frequency and TUNING dial pointer to 90 MHz (Mc); adjust generator output for ± 22.5 kHz (kc) deviation with 400 Hz (cps).
- Increase generator output voltage for reading on tuning meter of 2.5; vary generator frequency to insure that meter is at peak. Generator output voltage should be between 8 and 25 μ V. Note reading on AC VTVM.
- Set MUTING switch to ON. Adjust Muting Adjust Pot. R16 for reading on AC VTVM 1 to 5 db lower than that previously noted.
- Reduce generator voltage to zero—no signal (400 Hz modulation) or noise should be indicated on AC VTVM at RCDR jack.

INTERMODULATION DISTORTION TEST

Set BALANCE, BASS and TREBLE controls to their center positions. Set MODE/TAPE MONITOR switch to STEREO, SELECTOR switch to AUX and SPEAKERS switch to MAIN. Push LOUDNESS CONTOUR and HIGH FILTER switches to OFF. Unplug AC power cord.

- Connect a 4-ohm, 50-watt resistor across the LEFT SPKRS MAIN terminals. In parallel with the load resistor, connect the input leads of an IM (Inter-Modulation) distortion analyzer and the leads of an AC VTVM capable of reading 0.1 volts with accuracy.
- Connect IM-analyzer generator output to the LEFT AUX jack.

- NOTE:** Speaker common terminals are not at ground potential. IM distortion analyzer ground should be connected to AUX input ground only.
- Connect AC power cord and rotate VOLUME control to its maximum clockwise position—full volume.
- Increase IM-analyzer generator input to set for 25 watts output 8.2 VAC across 4-ohm load resistor. AFTER ONE FULL MINUTE OF WARM-UP TIME, PROCEED TO NEXT STEP.

- IM meter reading should be 0.8% or less.
 - Repeat preceding steps for the right channel.
- NOTE:** If any of the preceding instructions are different from those supplied with the IM-analyzer instruction manual, it is best to follow those in the manual. If a load resistor of 50-watt rating is built into the manual, a separate load resistor is not required. For best results, the IM range switch should be set to give a reading on the center to full-scale portion of the meter scale for greater accuracy.

HARMONIC DISTORTION TEST

Set BALANCE, BASS and TREBLE controls to their center positions. Set MODE/TAPE MONITOR switch to STEREO position, SELECTOR switch to AUX and SPEAKERS switch to MAIN. Set LOUDNESS CONTOUR and HIGH FILTER switches to OFF. Unplug AC power cord.

- Connect a 4-ohm, 50-watt resistor across LEFT SPKRS MAIN terminals. In parallel with the load resistor, connect the input leads of a harmonic distortion analyzer and the leads of an AC VTVM capable of reading 0.1 volts with accuracy.
- Connect a low-distortion audio sine wave generator, set for 1000 Hz, to the LEFT AUX jack.
- Connect AC power cord and rotate VOLUME control to its maximum clockwise (full volume) position.
- Increase generator input to set for 35 watts output (11.8 VAC across 4-ohm load resistor). Harmonic distortion meter should read less than 0.8%.
- Repeat preceding steps for right channel.

POWER OUTPUT MEASUREMENT

The output amplifier of this unit is designed to deliver its full-rated power with program material (voice or music) into 4-to 16-ohm loads for indefinite periods.

- When a constant audio tone is used as a signal to measure the continuous RMS power output, the following precautions must be taken:
 - Measure the power output of one channel at a time.
 - Limit the measurement period to 10 minutes with a load resistance between 4 and 16 ohms.
- If the power output of both channels must ever be measured simultaneously, use a load of 4 to 8 ohms per channel and limit measurements to a period not longer than 1 minute for a 4-ohm load and not longer than 5 minutes for an 8-ohm load.

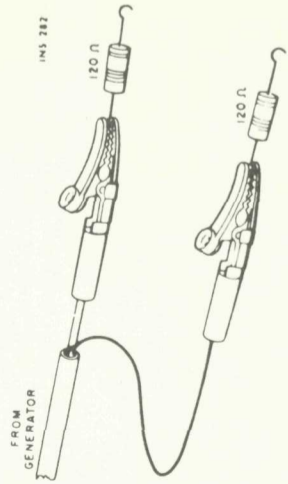
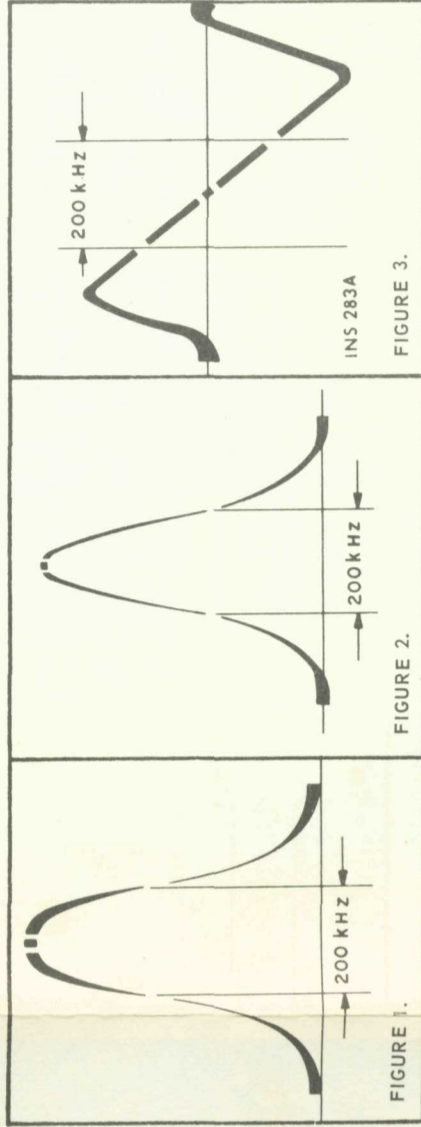

FIGURE 1. CONNECTIONS TO PROVIDE 300-OHM GENERATOR OUTPUT IMPEDENCE. MATCHING RESISTORS REDUCE GENERATOR VOLTAGE BY HALF AT THE ANTENNA TERMINALS.



SERVICE PROCEDURES

MULTIPLEX ALIGNMENT

Two methods of aligning the multiplex decoder are given. The preferred procedure uses a multiplex generator with RF and 19 kHz outputs and with 1 kHz modulation, such as the Fisher Model 300 Multiplex Generator. This is the better method of alignment since the front end and IF stages are also checked through the use of this procedure. An alternate procedure for use with multiplex generators not having an RF output is also given.

PREFERRED ALIGNMENT PROCEDURE

- Set MUTING switch to OFF and SELECTOR switch to FM AUTO.
 - Connect MPX generator to the LOC antenna terminals. Use two 120-ohm composition resistors in series with the generator leads.
 - Follow procedures given in Table 1 below.
- NOTE: Check the alignment of the IF amplifier before aligning the MPX decoder. Poor IF alignment can make proper multiplex adjustment impossible.

ALTERNATE ALIGNMENT PROCEDURE

- Set MUTING switch to OFF and SELECTOR switch to FM AUTO.
- Disconnect wire going to connection 4C on the multiplex board. Connect MPX generator to connection 4C.
- Follow procedures given in Table 2 below.
- After alignment is complete, disconnect MPX generator and reconnect lead coming from connection 3K on the IF board to connection 4C on the multiplex board.

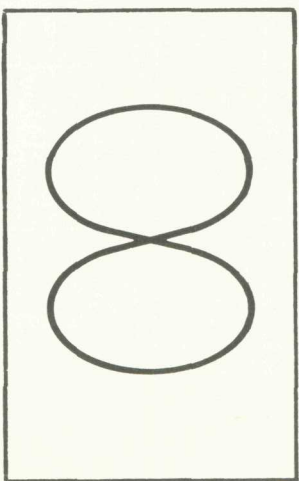

FIGURE 1. LISSAJOUS PATTERN FOR MPX ALIGNMENT.

TABLE 1
MULTIPLEX ALIGNMENT USING RF MULTIPLEX SIGNAL

STEP	GENERATOR MODULATION	RF DEV.	INDICATOR TYPE AND CONNECTION	ALIGNMENT	
				ADJUST	INDICATION
1	19KHz (kc) pilot only.	± 7.5 KHz (Kc)	DC VTVM to TP401	Z401 top & bottom, Z402	Maximum DC VTVM reading.
2	Short connection 4F to ground.	-	-	-	Stereo Beacon should light.
3	Connect portion of 19KHz (kc) generator output to scope horizontal input.	no mod.	Scope vertical input through 1 megohm resistor to TP403; scope set for external sweep.	Z403 top	Stable Lissajous pattern 2:1 (Figure 1) as slow moving as possible.
4	Same as Step 3.	no mod.	Same as Step 3	Z403 bottom	Maximum scope amplitude; adjust Z403 top as necessary for slowest moving Lissajous.
5	Disconnect connection 4F from ground.	-	-	-	-
6	Composite MPX signal 1KHz (kc) on left channel only.	± 7.5 KHz (Kc)	Audio (AC) VTVM and scope input to left channel output on preamp board.	Z402	Maximum audio AC VTVM reading; clean 1KHz (kc) sine wave on scope.
7	Composite MPX signal 1KHz (kc) on right channel only.	± 7.5 KHz (Kc)	Same as Step 6.	Separation Control*	Minimum audio AC VTVM reading—at least 30 db below reading in Step 6.
8	Same as Step 7.	± 7.5 KHz (Kc)	Audio (AC) VTVM and scope input to right channel output on preamp board.	-	Same audio AC VTVM reading as obtained in Step 6 (± 2 db); clean 1KHz (kc) sine wave on scope.
9	Same as Step 6.	± 7.5 KHz	Same as Step 8.	-	Minimum audio AC VTVM reading—at least 30 db below reading in Step 8.
10	19KHz (kc) pilot only.	± 3.5 KHz (Kc)	DC VTVM to connection 4F.	Trigger Control	Stereo Beacon lights up with 0.8 V reading on DC VTVM.

* NOTE: Separation Control is located on preamplifier board.

TESTING THE POWER AMPLIFIER

CAUTION

DO NOT use uninsulated clips on any connection except to the chassis. Always use miniature insulated clips when connecting to component leads, socket lugs and terminal strips—it takes only a fraction of a second to destroy a transistor with an accidental short circuit. Make sure metal-cased instruments are not touching the chassis directly or through other instruments and common-ground leads.

- WARNING:** Disconnect AC power cord while removing or inserting transistors.
- Remove transistors Q1 to Q4, Q801 to Q804 and Q851, Q852 and Q853 (both channels) from their sockets. Label each transistor with its location in the unit.
 - Set VOLUME control to its minimum position (extreme counterclockwise).
 - Set line voltage through an adjustable transformer to 117 VAC. Plug in AC power cord.
 - Connect common lead of DC VTVM to the chassis.
 - Measure voltage across filter capacitor C19 or at the B+ terminal of the bridge rectifier; reading should be 55 ± 2 VDC.
 - Measure voltage at junction of resistor R50 and zener diode CR2; reading should be 112 ± 0.6 VDC.
 - Measure voltage at junction of resistor R51 and zener diode

TABLE 2
MULTIPLEX ALIGNMENT USING COMPOSITE MULTIPLEX SIGNAL

STEP	GENERATOR MODULATION	LEVEL (RMS)	INDICATOR TYPE AND CONNECTION	ALIGNMENT	
				ADJUST	INDICATION
1	19KHz (kc) pilot only.	Vary 0 to 50mV	DC VTVM to TP401	Z401 top & bottom, Z402	Maximum DC VTVM reading.
2	Short connection 4F to ground.	-	-	-	Stereo Beacon should light.
3	Connect portion of 19KHz (kc) generator output to scope horizontal input.	Vary 0 to 50mV	Scope vertical input through 1 megohm resistor to TP403; scope set for external sweep.	Z403 top	Stable Lissajous pattern 2:1 (Figure 1) as slow moving as possible.
4	Same as Step 3.	Vary 0 to 50mV	Same as Step 3.	Z403 bottom	Maximum scope amplitude; adjust Z403 top as necessary for slowest moving Lissajous.
5	Disconnect connection 4F from ground.	-	-	-	-
6	Composite MPX signal 1KHz (kc) on left channel only.	100mV (560mV P-P)	Audio (AC) VTVM and scope input to left channel output on preamp board.	Z402	Maximum audio AC VTVM reading; clean 1KHz (kc) sine wave on scope.
7	Composite MPX signal 1KHz (kc) on right channel only.	100mV (560mV P-P)	Same as Step 6.	Separation Control*	Minimum audio AC VTVM reading—at least 30 db below reading in Step 6.
8	Same as Step 7.	100mV (560mV P-P)	Audio (AC) VTVM and scope input to right channel output on preamp board.	-	Same audio AC VTVM reading as obtained in Step 6 (± 2 db); clean 1KHz (kc) sine wave on scope.
9	Same as Step 6.	100mV (560mV P-P)	Same as Step 8.	-	Minimum audio AC VTVM reading—at least 30 db below reading in Step 8.
10	19KHz (kc) pilot only.	Vary 0 to 50mV	DC VTVM to connection 4F.	Trigger Control	Stereo Beacon lights up with 0.8 V reading on DC VTVM.

* NOTE: Separation Control is located on preamplifier board.

- CR3; reading should be 24 ± 1.2 VDC.
- Insert left channel pre-driver transistors Q801 and Q803 (Q802, Q804—right channel) in their sockets on the pre-driver board.
- Measure voltage at connection 8Q on left channel driver board; reading should be 10 ± 1 VDC.
- Insert voltage driver transistor Q851 in left channel driver board and measure voltage at the collector. Adjust left channel Center Voltage Adjust Pot. R857 for a collector voltage of 31 VDC.
- Measure voltage from base-to-base socket terminals of power driver transistors Q852, Q853 on left channel driver board. Adjust left channel Output Bias Adjust Pot. R858 for reading of 2.3 VDC.
- Insert left channel power driver transistors Q852, Q853 in their sockets.
- Measure voltage at connection 8H on left channel driver board; reading should be between 24 and 31 VDC.
- Insert left channel power transistors Q3, Q4, Q1, Q2—right channel).
- Measure voltage across resistors R37 and R39 (R38 and R40—right channel); reading should be between 40 and 60 mv across each resistor. If the reading cannot be obtained, perform the Power Amplifier Center Voltage Adjustment and the Power Amplifier Current Adjustment (page 1).

- NOTE: VTVM must have a 250volt or lower full-scale range to make this reading properly.
- Repeat preceding steps for the right channel.

FE50D965 FM FRONT END

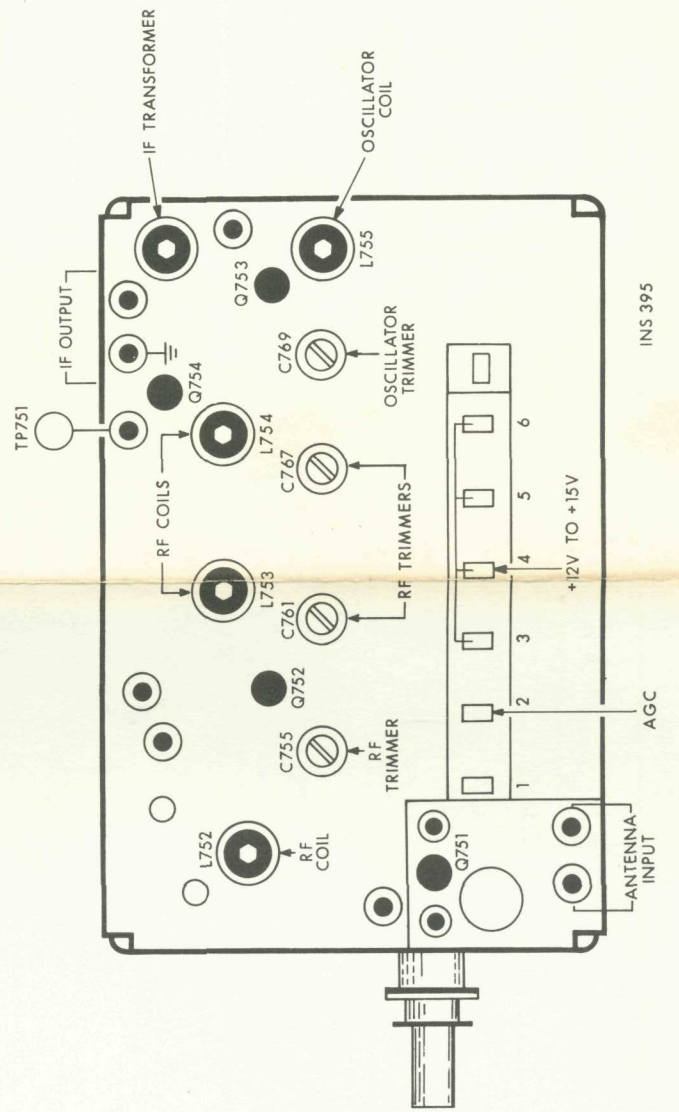
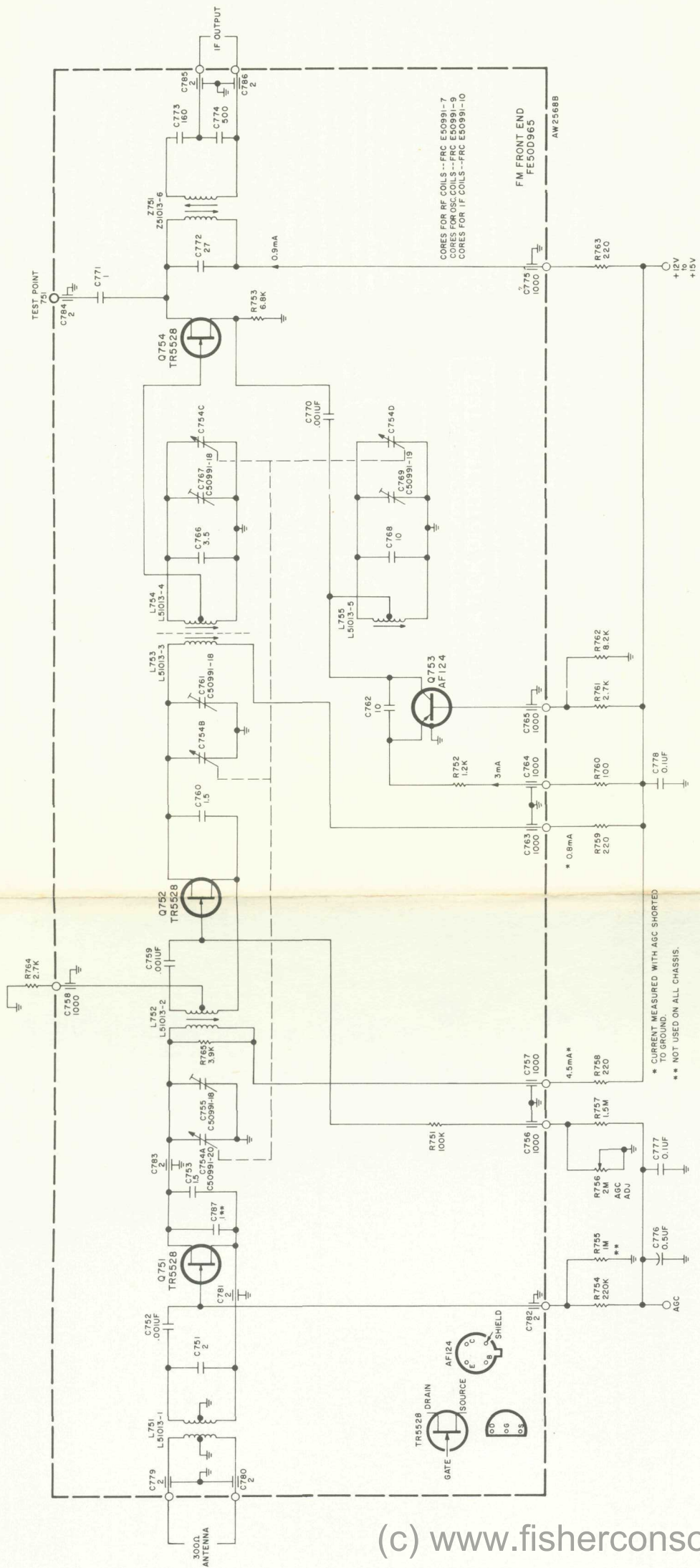

1381-1 10.7 MHz IF AMPLIFIER

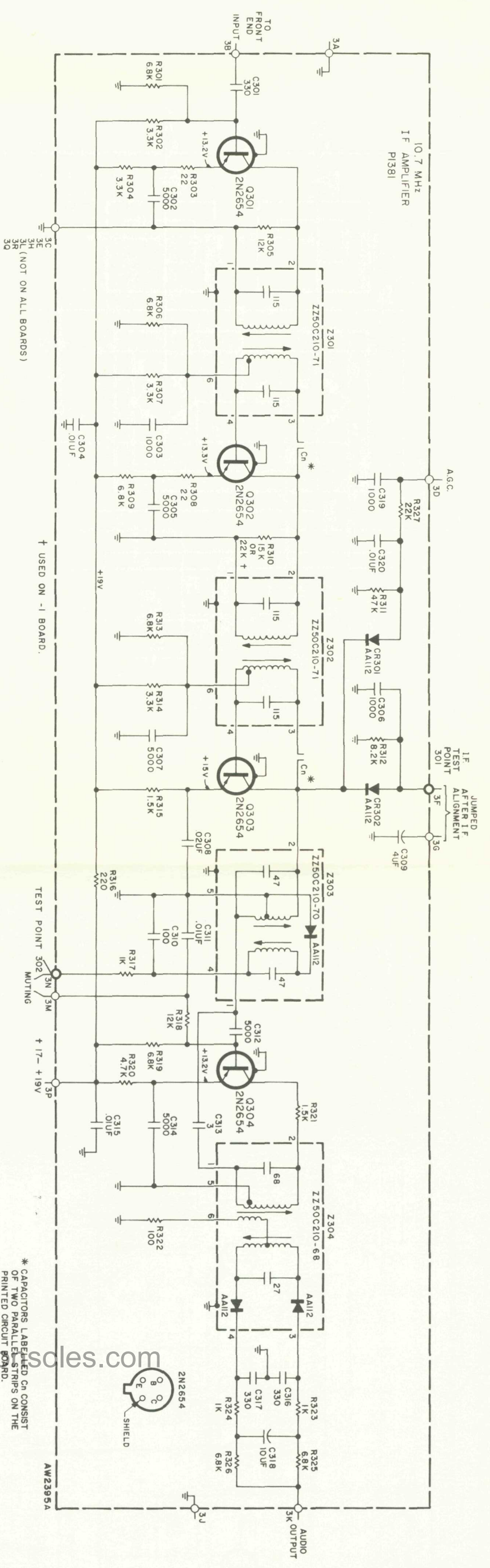

BOARD VIEWED FROM COMPONENT SIDE

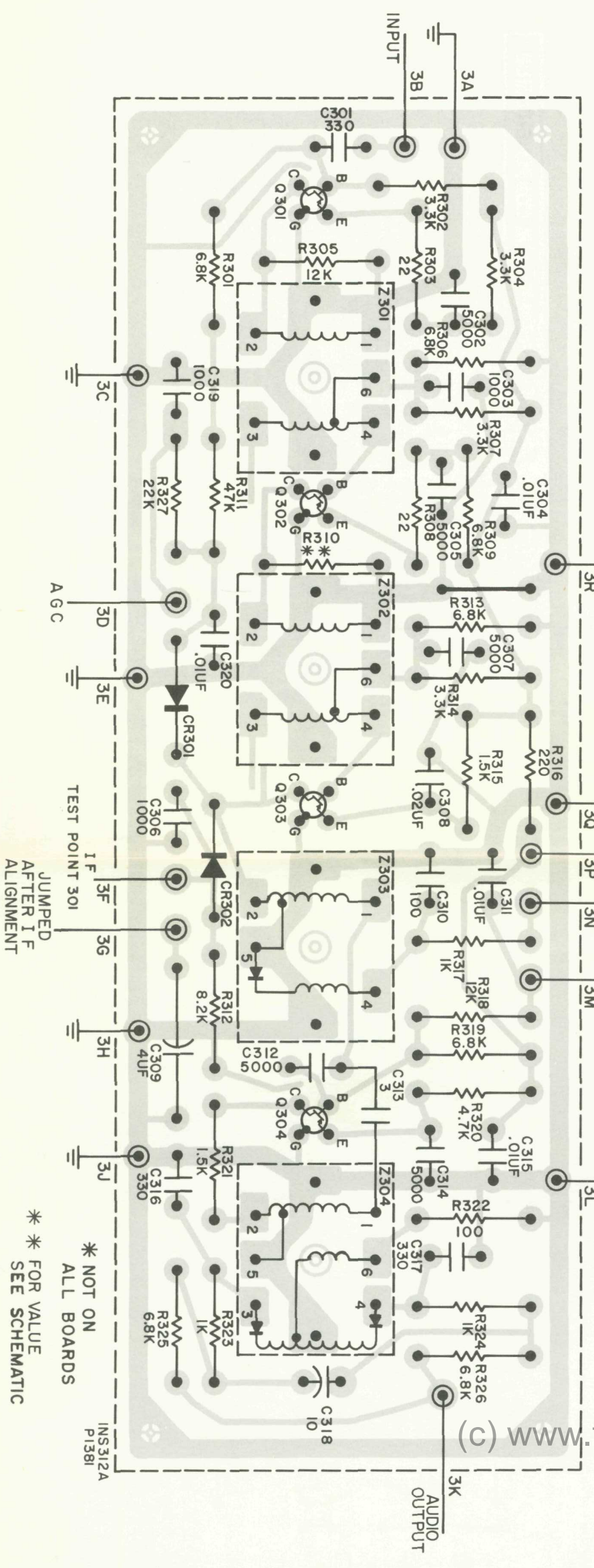

** NOT ON ALL BOARDS
** FOR VALUE SEE SCHEMATIC

* CAPACITORS LABELLED ON CONSIST OF TWO PARALLEL STRIPS ON THE PRINTED CIRCUIT BOARD.

AW2395A

1531 MULTIPLEX DECODER

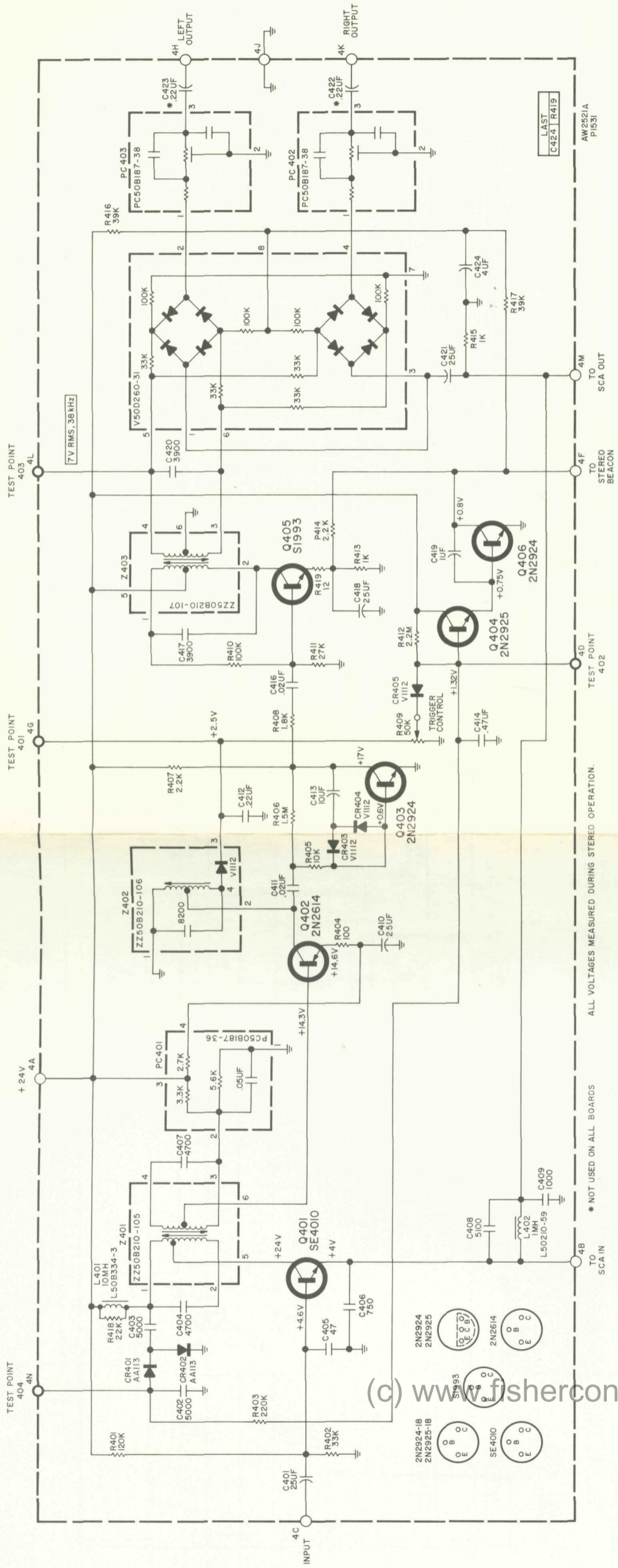

BOARD VIEWED FROM COMPONENT SIDE

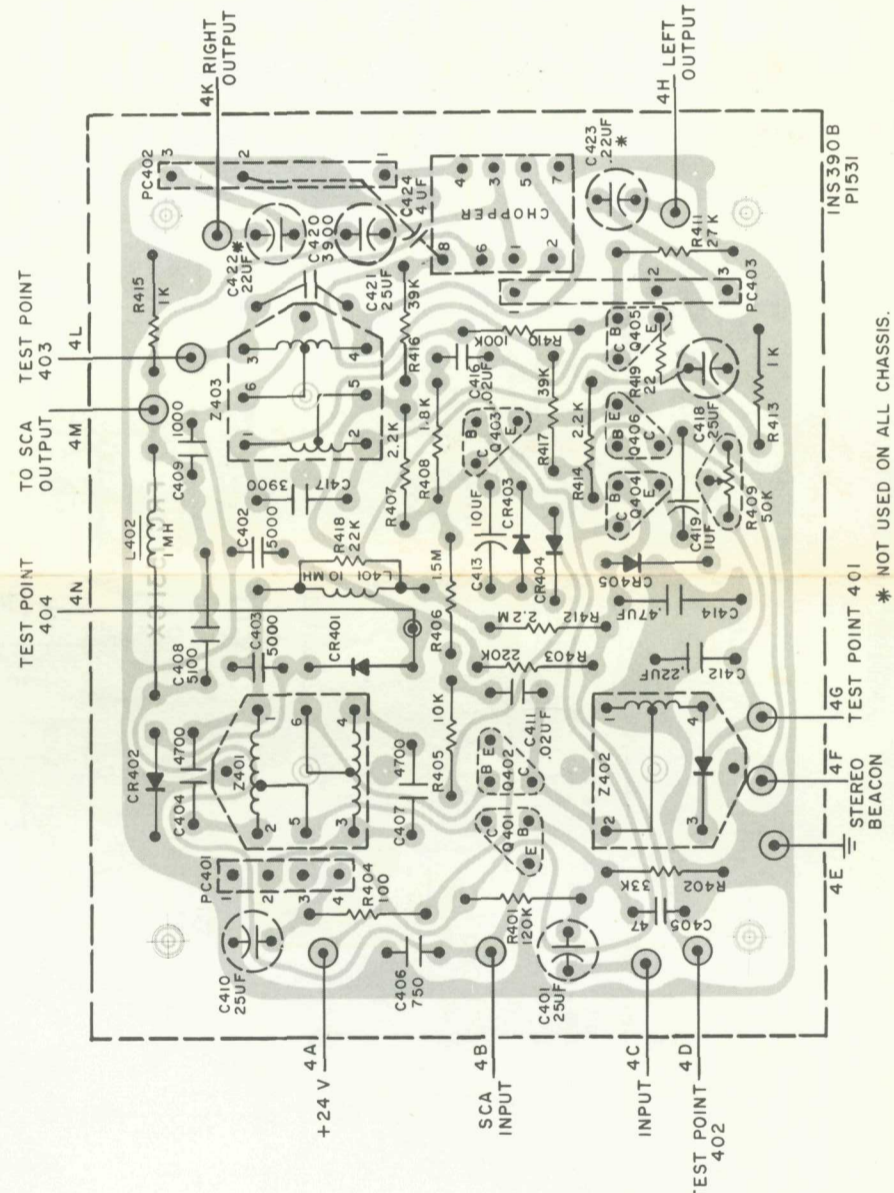

(c) www.fisherconsoles.com

1398-3 PREAMPLIFIER

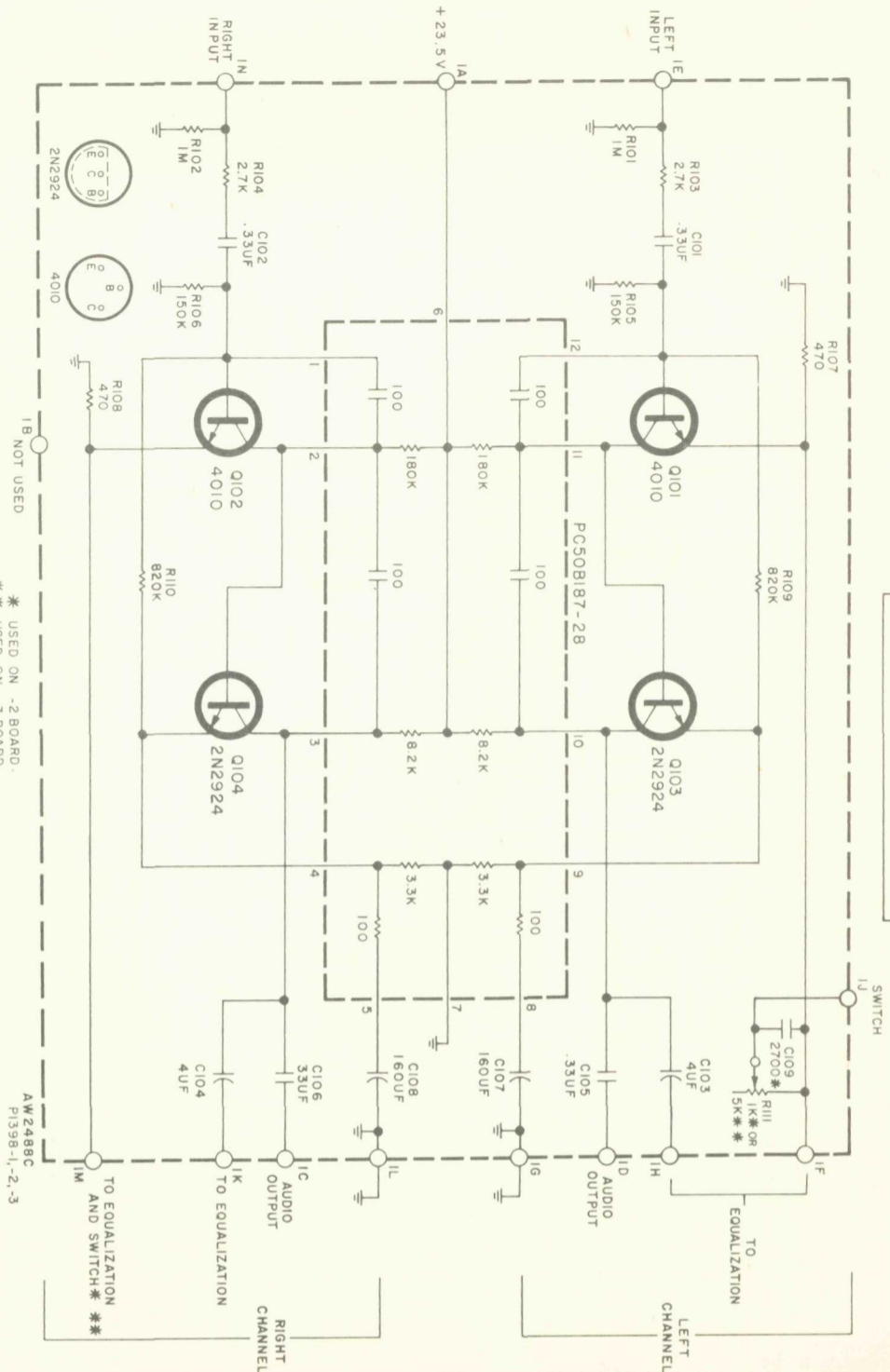

BOARD VIEWED FROM THE COMPONENT SIDE

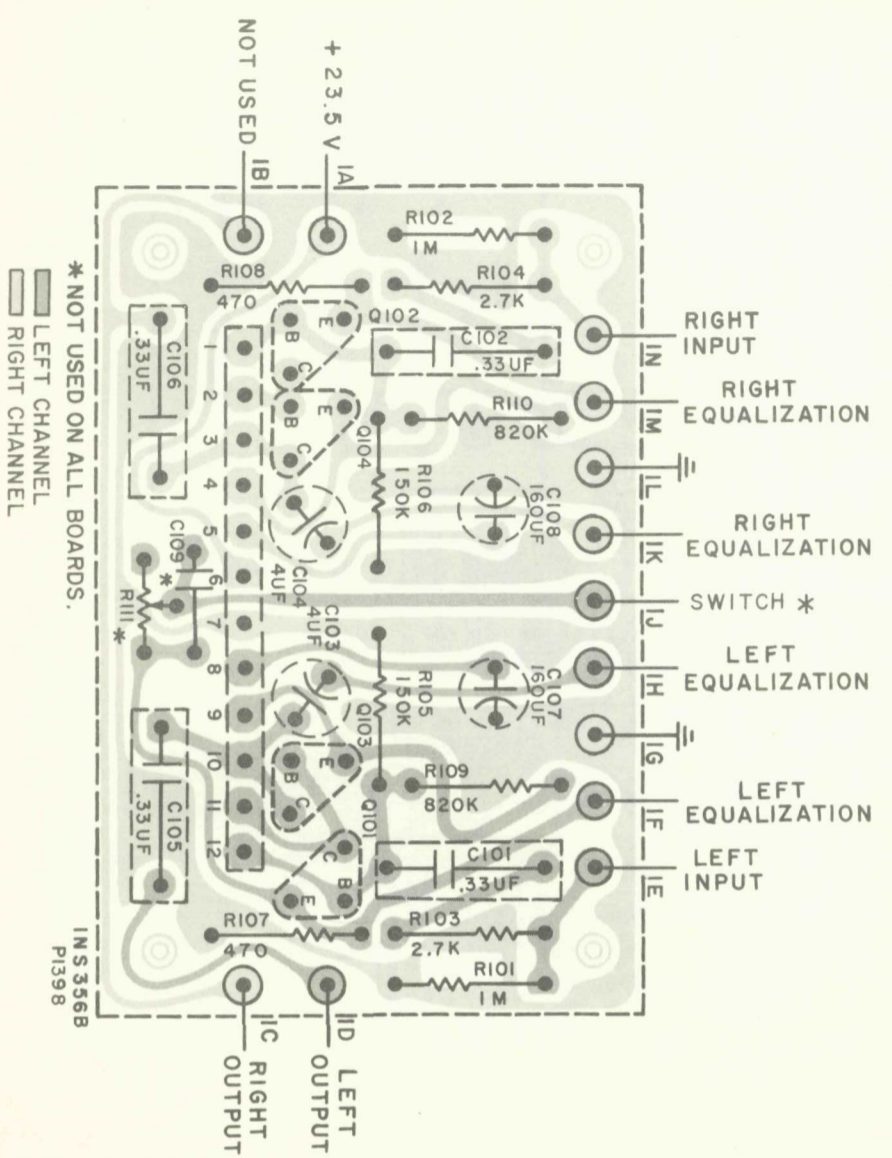

1478-2 PREDRIVER

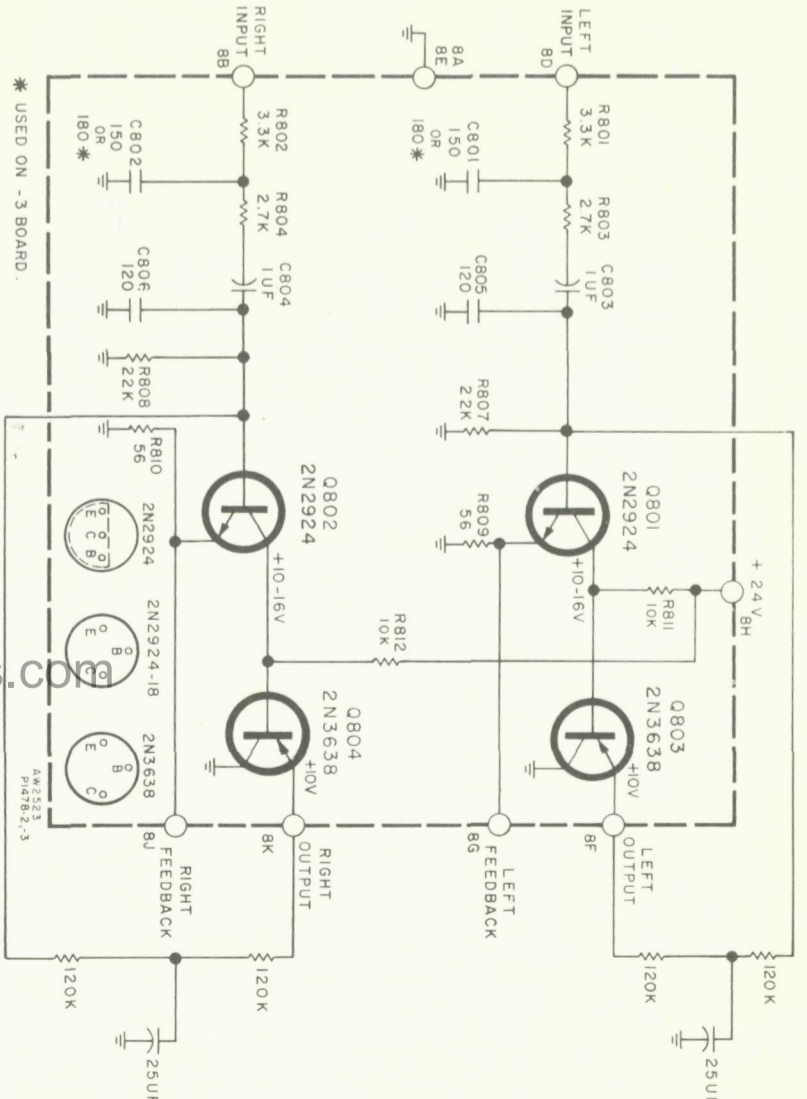

BOARD VIEWED FROM COMPONENT SIDE

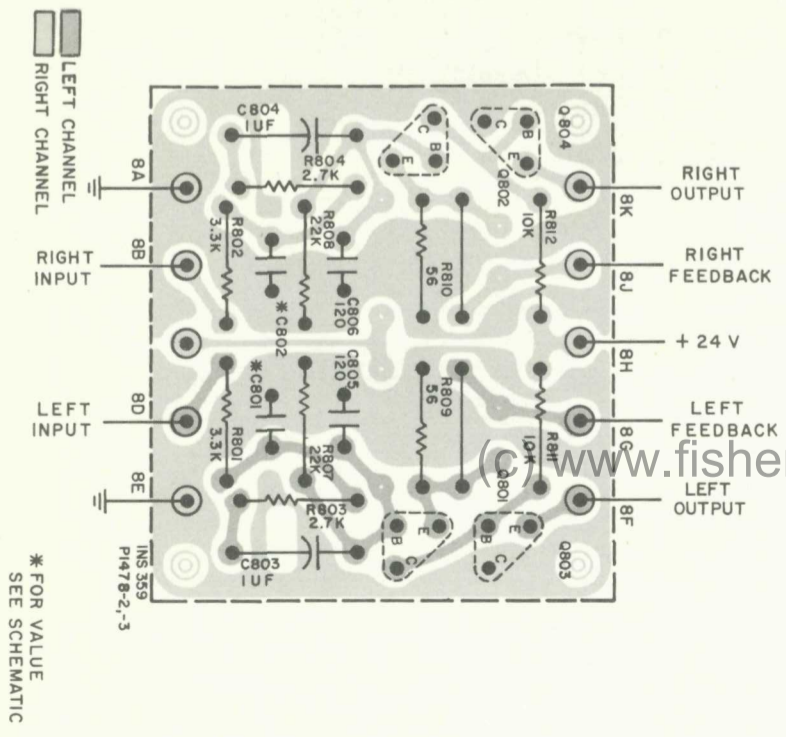

1278-3 AUDIO CONTROL AMPLIFIER

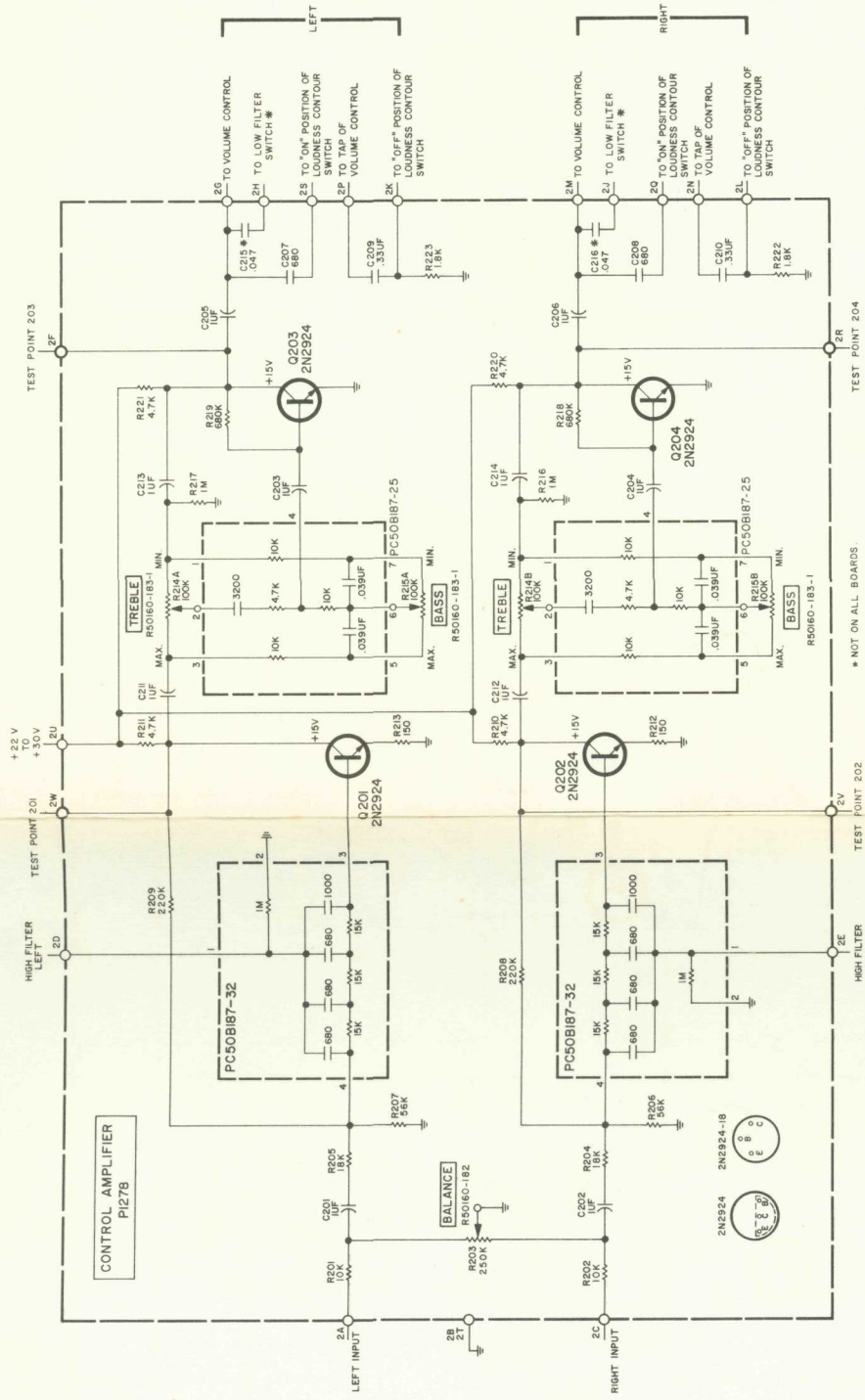

BOARD VIEWED FROM THE COMPONENT SIDE

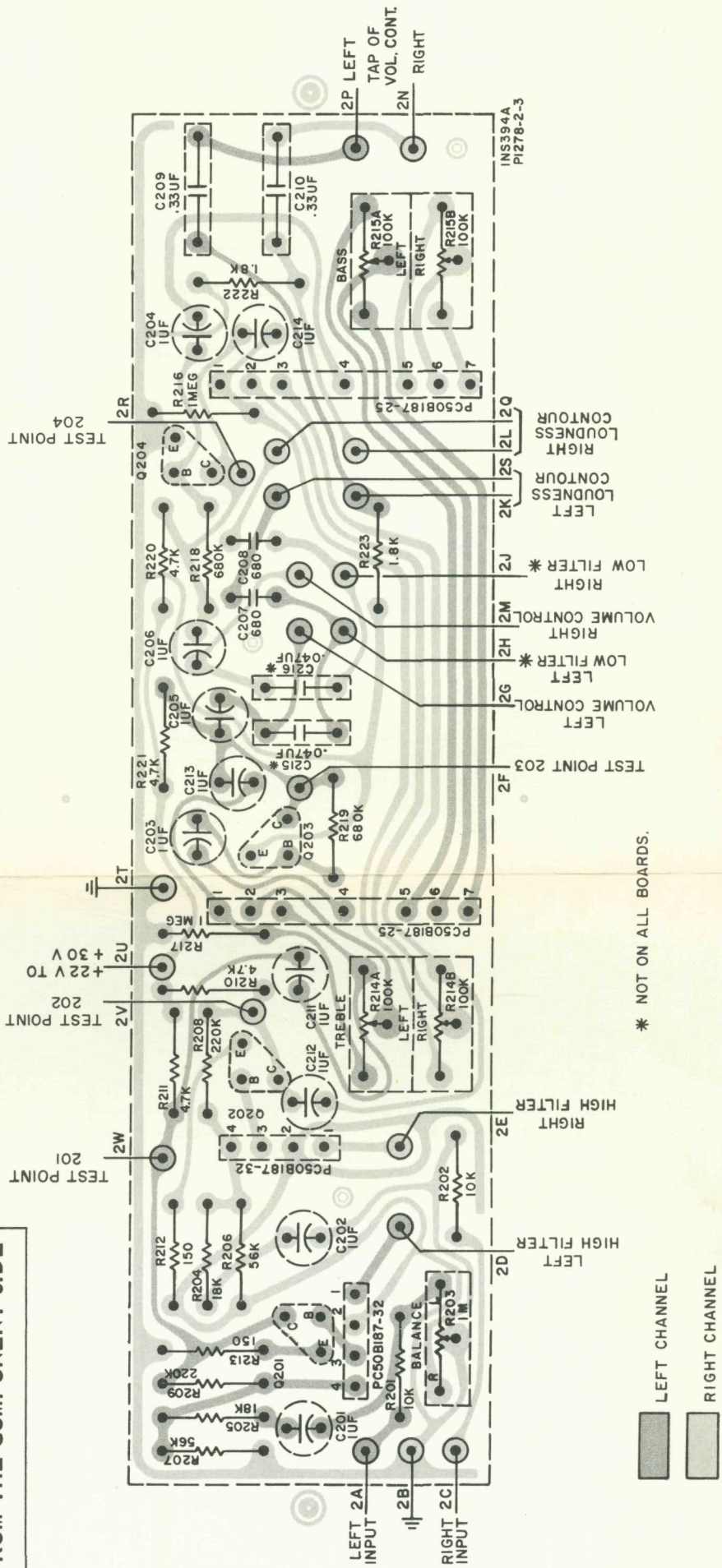

MAIN CHASSIS

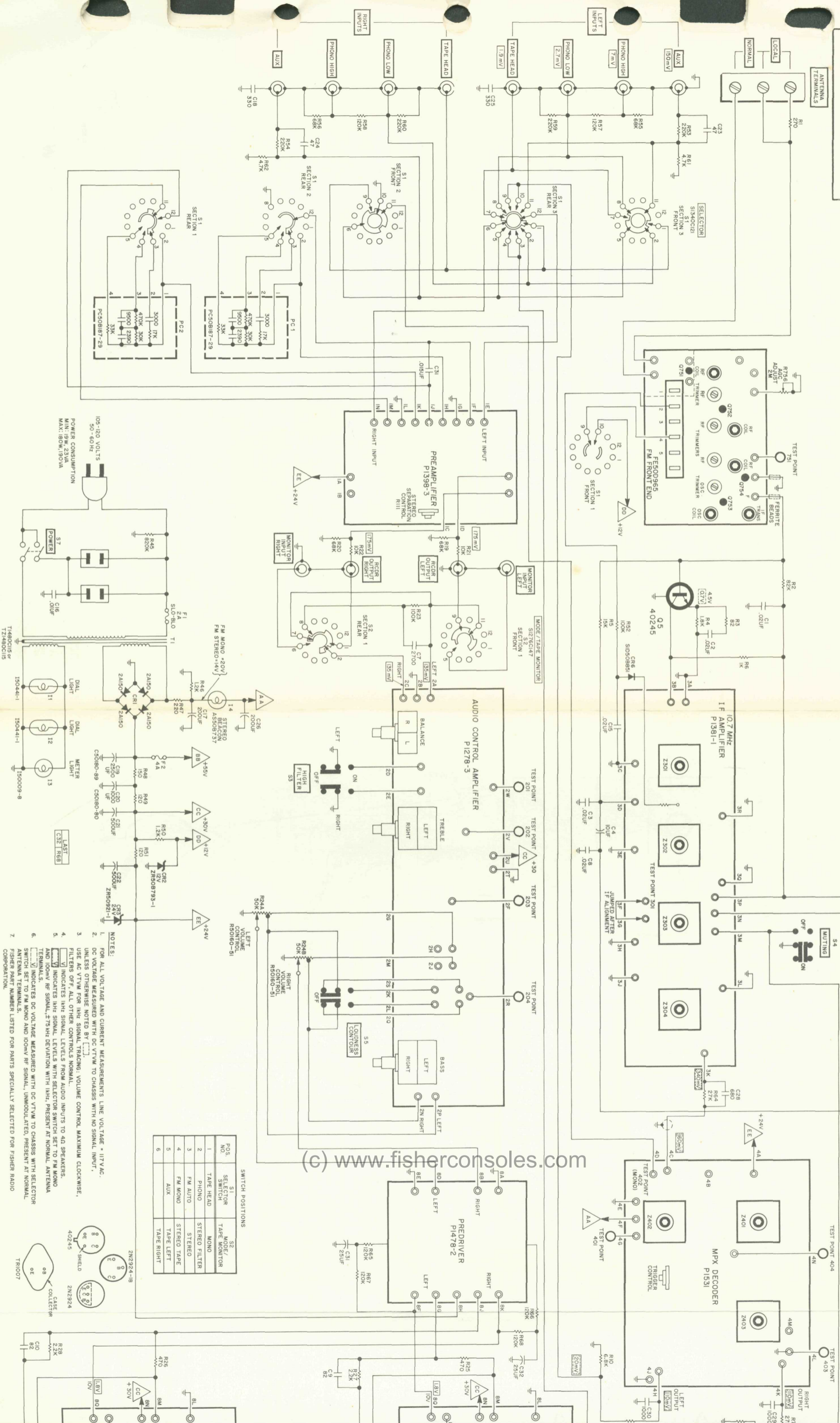

POWER CONSUMPTION
50-100 VOLTS
50-60HZ
MIN.: 9W, 233mA
MAX.: 180W, 190VVA

- NOTES:
- FOR ALL VOLTAGE AND CURRENT MEASUREMENTS, LINE VOLTAGE = 117VAC.
 - DC VOLTAGE MEASURED WITH DC VTVM TO CHASSIS WITH NO SIGNAL INPUT.
 - UNLESS OTHERWISE NOTED BY [] .
 - USE AC VTVM FOR IHH SIGNAL TRACING; VOLUME CONTROL, MAXIMUM CLOCKWISE.
 - FILTERS OFF, ALL OTHER CONTROLS NORMAL.
 - [] INDICATES IHH SIGNAL LEVELS FROM AUDIO INPUTS TO 4Ω SPEAKERS.
 - [] INDICATES IHH SIGNAL LEVELS WITH SELECTOR SWITCH SET TO FM MONO AND 100mV RF SIGNAL, ±75Hz DEVIATION WITH IHH, PRESENT AT NORMAL ANTENNA TERMINALS.
 - [] INDICATES DC VOLTAGE MEASURED WITH DC VTVM TO CHASSIS WITH SELECTOR SWITCH SET TO FM MONO AND 100mV RF SIGNAL, UNMODULATED, PRESENT AT NORMAL ANTENNA TERMINALS.
 - FISHER PART NUMBER LISTED FOR PARTS SPECIALLY SELECTED FOR FISHER RADIO CORPORATION.

SWITCH POSITIONS

POS NO.	SELECTOR SWITCH	TAPE MODE/TAPE MONITOR
1	TAPE HEAD	MONO
2	PHONO	STEREO FILTER
3	FM AUTO	STEREO
4	FM MONO	STEREO TAPE
5	AUX	TAPE LEFT
6		TAPE RIGHT

(c) www.fisherconsoles.com

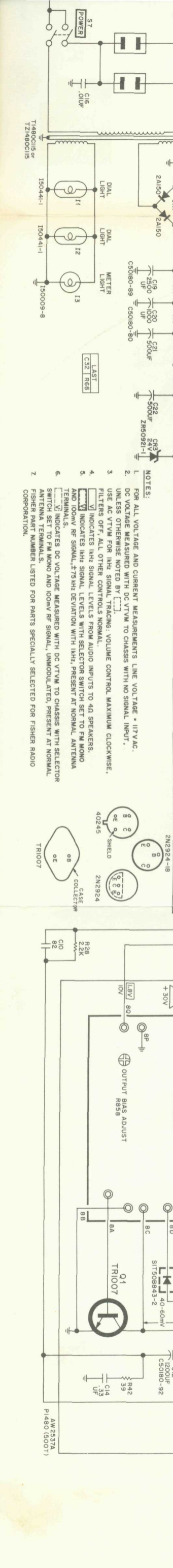
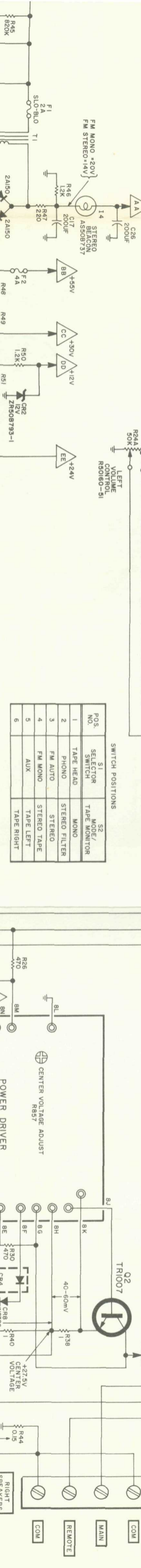
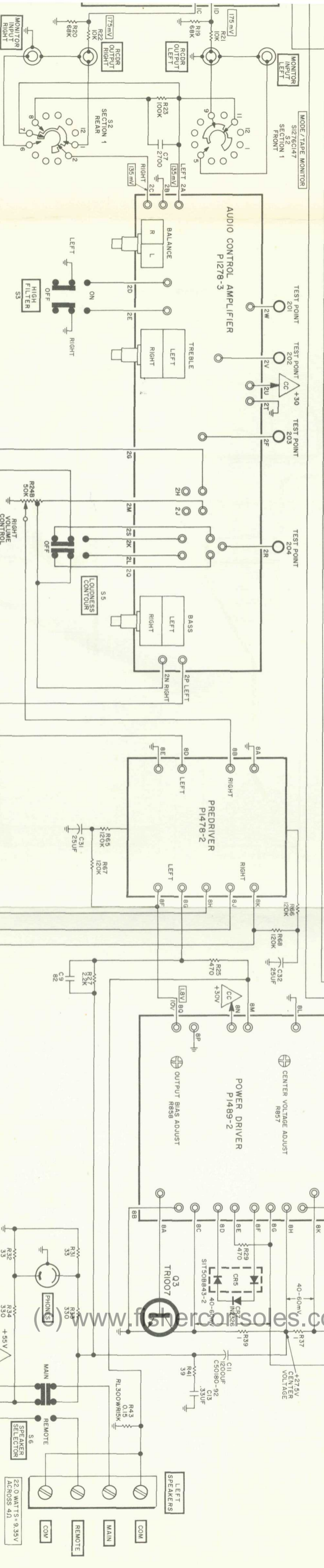
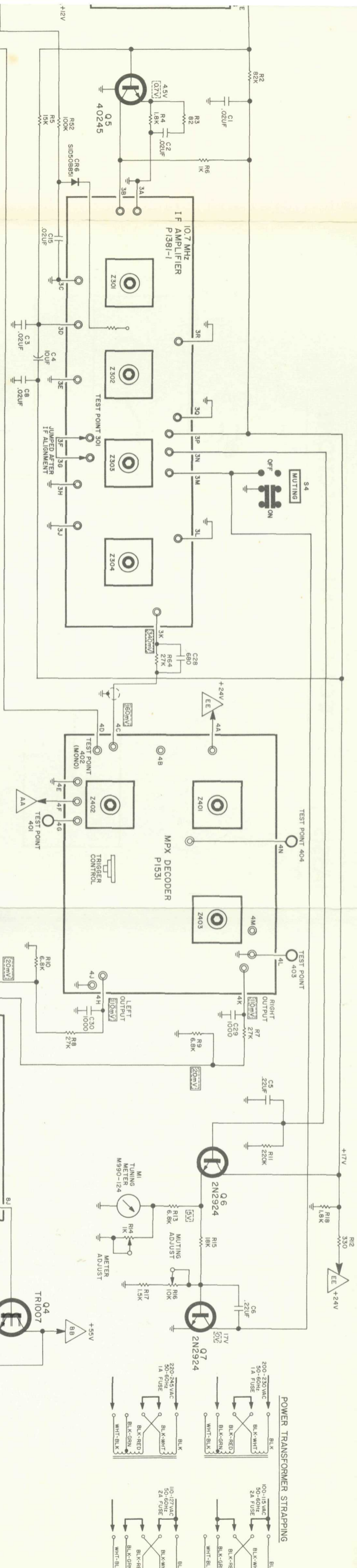

SWITCH POSITIONS

POS. NO.	SELECTOR SWITCH	MODE/TAPE MONITOR
1	TAPE HEAD	MONO
2	PHONO	STEREO FILTER
3	FM AUTO	STEREO
4	FM MONO	STEREO TAPE
5	AUX	TAPE LEFT
6		TAPE RIGHT

- NOTES:
- FOR ALL VOLTAGE AND CURRENT MEASUREMENTS LINE VOLTAGE = 117 VAC.
 - DC VOLTAGE MEASURED WITH DC VTVM TO CHASSIS WITH NO SIGNAL INPUT, UNLESS OTHERWISE NOTED BY []
 - USE AC VTVM FOR IHH SIGNAL TRACING; VOLUME CONTROL MAXIMUM CLOCKWISE.
 - FILTERS OFF, ALL OTHER CONTROLS NORMAL.
 - [] INDICATES IHH SIGNAL LEVELS FROM AUDIO INPUTS TO 4Ω SPEAKERS.
 - [] INDICATES IHH SIGNAL LEVELS WITH SELECTOR SWITCH SET TO FM MONO TERMINALS.
 - [] INDICATES DC VOLTAGE MEASURED WITH DC VTVM TO CHASSIS WITH SELECTOR SWITCH SET TO FM MONO AND 100mV RF SIGNAL, UNMODULATED, PRESENT AT NORMAL ANTENNA TERMINALS.
 - FISHER PART NUMBER LISTED FOR PARTS SPECIALLY SELECTED FOR FISHER RADIO CORPORATION.

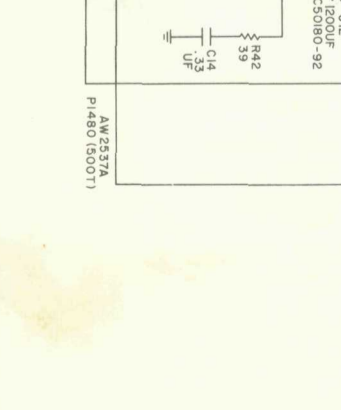

CHASSIS LAYOUT

TOP

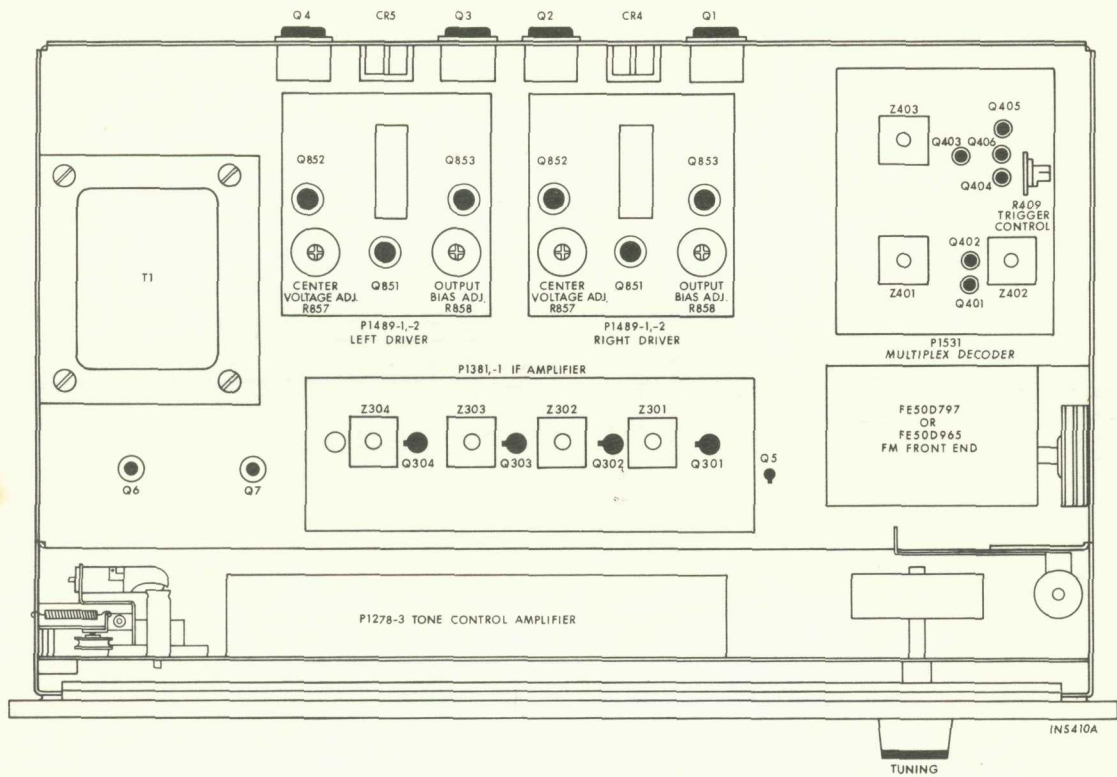

BOTTOM

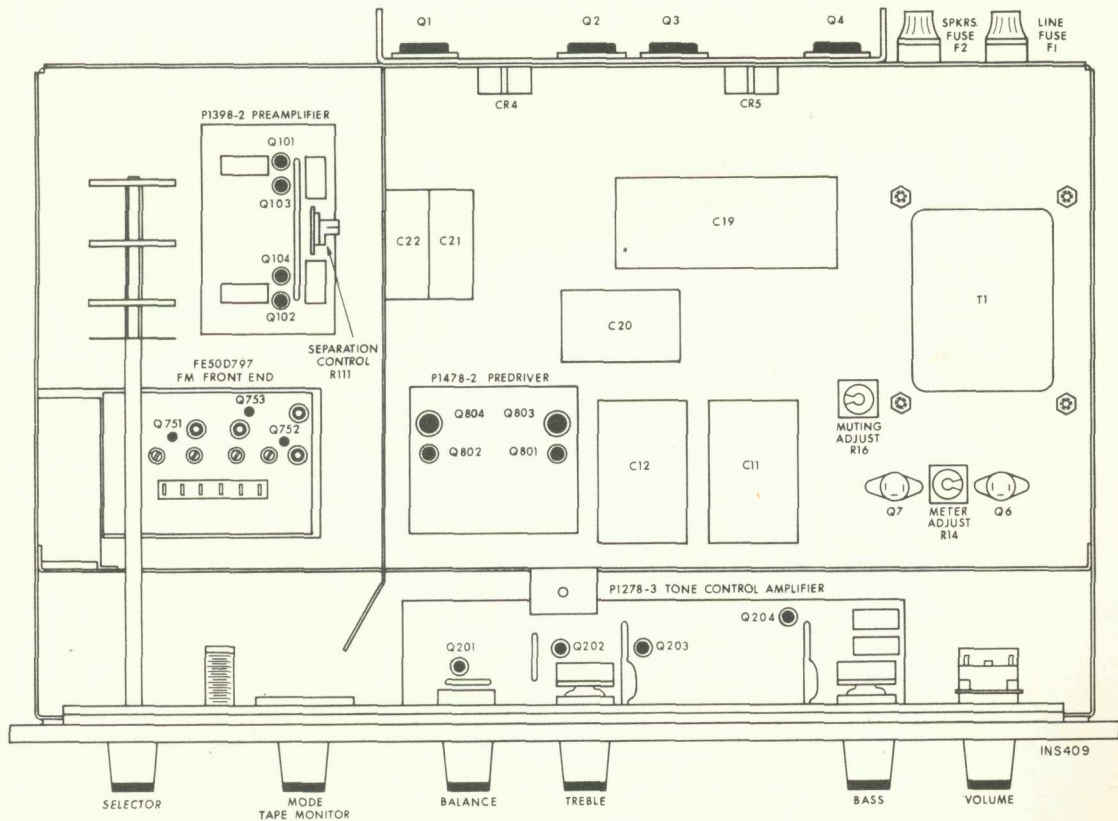

FISHER RADIO CORPORATION • NEW YORK

NI480-103

© COPYRIGHT 1966 FISHER RADIO CORPORATION PRINTED IN U. S. A.

(c) www.fisherconsoles.com